

EMC Components

ZBYS Series

Common Mode Choke Coils for Signal Line and DC Power Line SMD

FEATURES

- For distortion-free removal of noise from transmitted electrical signals. Best common mode filter for transmission of high quality signals.
- Best filter for countering the common mode noise resulting from data signal processing by PCs, phone equipment, etc.
- Highly appropriate for IC board mounting due to DIP-type structure.

APPLICATIONS

PCs, telephones, LANs, ISDN lines, digital PBX, game machines, cable TV equipment, CD-ROM players, 8mm video equipment, etc.

SHAPES AND DIMENSIONS/CIRCUIT DIAGRAM

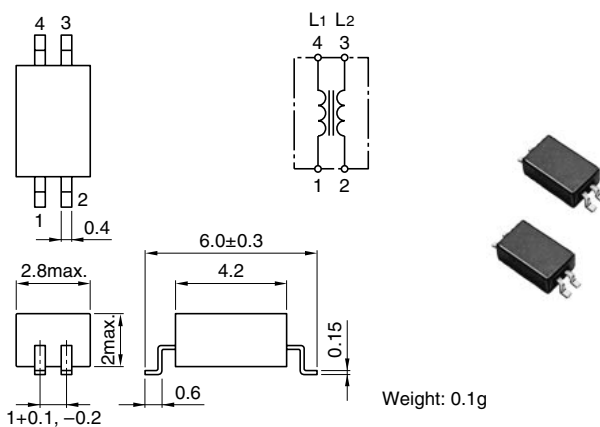

RECOMMENDED PC BOARD PATTERN

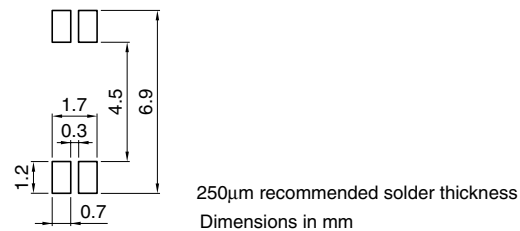

ELECTRICAL CHARACTERISTICS

Part No.	ZBYS5101-2PT
Rated voltage $E_{dc}(V)$	50
Rated current (A)	2
DC resistance (Ω)[each line]	0.5max.
Operating temperature range($^{\circ}C$)	-25 to +85
Impedance(Ω)[+5 to +35 $^{\circ}C$]	20min.[20 to 500MHz]

PACKAGING STYLE AND QUANTITIES

Packaging style	Quantity
Taping	2000 pieces/reel

TYPICAL ELECTRICAL CHARACTERISTICS

IMPEDANCE vs. FREQUENCY CHARACTERISTICS (per 1element)

