

## 3-terminal Filters(SMD)

For power line, T-type

### ACH series

Type:	<b>ACH32C</b>	<b>[1206 inch]*</b>
	<b>ACH3218</b>	<b>[1207 inch]</b>
	<b>ACH4518</b>	<b>[1807 inch]</b>
		<b>* Dimensions Code JIS[EIA]</b>

Issue date: December 2010

- All specifications are subject to change without notice.
  - Conformity to RoHS Directive: This means that, in conformity with EU Directive 2002/95/EC, lead, cadmium, mercury, hexavalent chromium, and specific bromine-based flame retardants, PBB and PBDE, have not been used, except for exempted applications.
-

# 3-terminal Filters(SMD) For Power Line

Conformity to RoHS Directive

## ACH Series ACH32C Type

### FEATURES

- These T-type EMC filters comprise ferrite beads and chip capacitors and are engineered to handle high current levels.
- They provide highly effective EMC suppression.
- Because their structures are almost entirely ferrite, they exhibit excellent attenuation characteristics.
- Because guarantee temperature range is  $-40$  to  $+125^{\circ}\text{C}$ , it is possible to use in strict environmental condition.
- Available for reflow soldering.

### APPLICATIONS

Home electronic equipment, (TVs, VCRs, CD players, DAT players, electric musical instruments, PCs, etc.), office automation equipment (computers, terminals, stand-alone word processors, fax machines, etc.), factory automation equipment (robots, numerical control devices, process controllers, etc.), automotive electronics (car navigation, ECU, etc.)

### PRODUCT IDENTIFICATION

ACH 32C - 103 - T □□□  
 (1) (2) (3) (4) (5)

- (1) Series name  
 (2) Dimensions  
 32C: 3216 type(3.2×1.6mm)  
 (3) Capacitance  
 103: 10000pF  
 (4) Packaging style  
 T:  $\phi$ 180mm reel taping  
 TL:  $\phi$ 330mm reel taping  
 (5) TDK internal code

### TEMPERATURE RANGES

Operating/Storage	$-40$ to $+125^{\circ}\text{C}$
-------------------	---------------------------------

### PACKAGING STYLE AND QUANTITIES

Packaging style	Reel	Quantity
Taping	$\phi$ 180mm	2000 pieces/reel
	$\phi$ 330mm	10000 pieces/reel

### SHAPES AND DIMENSIONS/CIRCUIT DIAGRAM

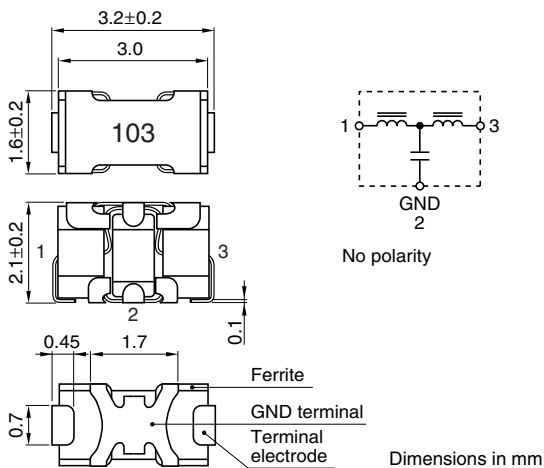

### RECOMMENDED PC BOARD PATTERN REFLOW SOLDERING

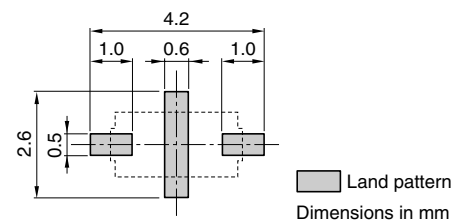

- Conformity to RoHS Directive: This means that, in conformity with EU Directive 2002/95/EC, lead, cadmium, mercury, hexavalent chromium, and specific bromine-based flame retardants, PBB and PBDE, have not been used, except for exempted applications.
- Please contact our Sales office when your application are considered the following:  
 The device's failure or malfunction may directly endanger human life (e.g. application for automobile/aircraft/medical/nuclear power devices, etc.)
- All specifications are subject to change without notice.

## ELECTRICAL CHARACTERISTICS

Part No.	Rated voltage Edc(V)max.	Rated current (A)max.	Insulation resistance (M $\Omega$ )min.	DC resistance (m $\Omega$ )max.	Guaranteed attenuation (dB)	Guaranteed frequency bandwidth (MHz)
ACH32C-100-T001	50	6	100	2	-15	2000 to 6000
ACH32C-220-T001	50	6	100	2	-15	1300 to 2500
ACH32C-470-T001	50	6	100	2	-15	650 to 2500
ACH32C-101-T001	50	6	100	2	-20	450 to 1300
ACH32C-331-T001	50	6	100	2	-20	200 to 800
ACH32C-102-T001	50	6	100	2	-25	100 to 350
ACH32C-222-T001	50	6	100	2	-25	55 to 300
ACH32C-103-T001	50	6	100	2	-25	30 to 200
ACH32C-333-T001	50	6	100	2	-25	10 to 300
ACH32C-104-T001	50	6	100	2	-25	3.5 to 200

## TYPICAL ELECTRICAL CHARACTERISTICS

### ATTENUATION vs. FREQUENCY CHARACTERISTICS

(Glass epoxy coated double side mounting PCB)

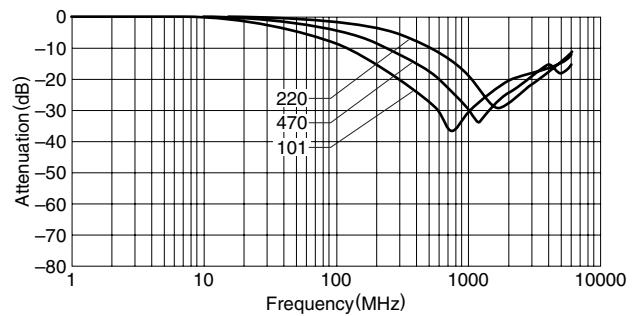
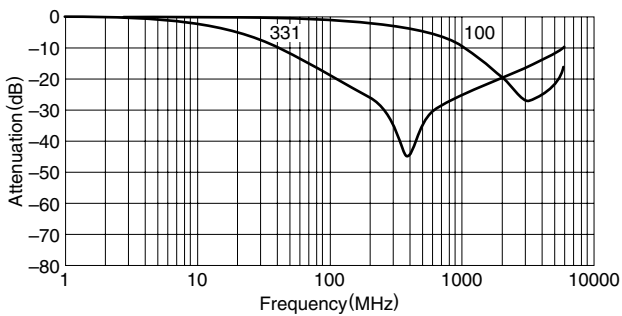
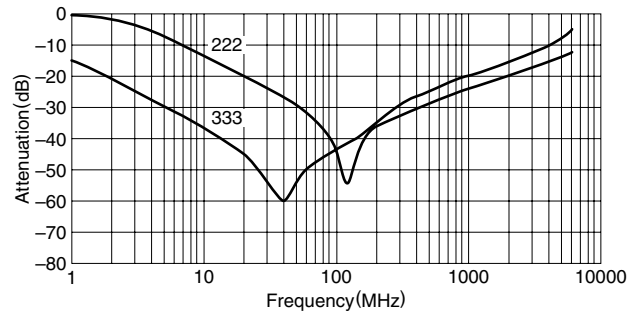
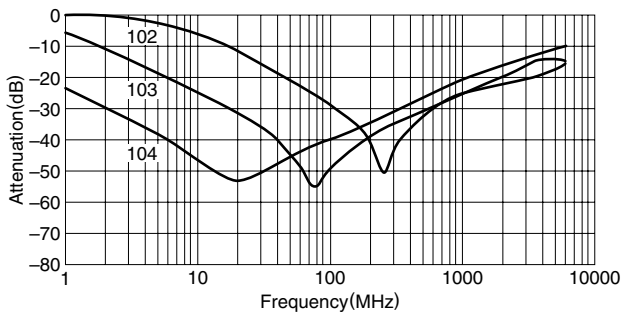

## CIRCUIT DIAGRAM

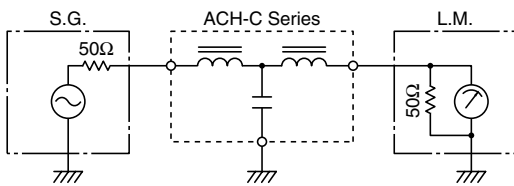

# 3-terminal Filters(SMD) For Power Line

Conformity to RoHS Directive

## ACH Series ACH3218, 4518 Types

### FEATURES

- The ACH series consists of products with superior attenuation characteristics, in which the T-type filter circuit is magnetically shielded with ferrite.
- The series offers even greater attenuation characteristics when used in a stable circuit on the ground.
- The ACH series is ideal for high-density circuit design, since the series is vertically mounted and does not require much mounting space.
- Available for reflow soldering.
- It is a product conforming to RoHS directive.

### PRODUCT IDENTIFICATION

ACH	3218	-	223	-	T	D	□	□
(1)	(2)	(3)	(4)	(5)				

- (1) Series name  
 (2) Dimensions  
 (3) Type  
 (4) Packaging style  
 (5) TDK internal code

### TEMPERATURE RANGES

Operating/Storage	-40 to +125°C
-------------------	---------------

### PACKAGING STYLE AND QUANTITIES

Packaging style	Quantity
Taping	1000 pieces/reel

### HANDLING AND PRECAUTIONS

- Before soldering, be sure to preheat components. The preheating temperature should be set so that the temperature difference between the solder temperature and product temperature does not exceed 150°C.
- After mounting components onto the printed circuit board, do not apply stress through board bending or mishandling.
- The inductance value may change due to magnetic saturation if the current exceeds the rated maximum.
- Do not expose the inductors to stray magnetic fields.
- Avoid static electricity discharge during handling.
- When hand soldering, apply the soldering iron to the printed circuit board only. Temperature of the iron tip should not exceed 350°C. Soldering time should not exceed 3 seconds.

• Conformity to RoHS Directive: This means that, in conformity with EU Directive 2002/95/EC, lead, cadmium, mercury, hexavalent chromium, and specific bromine-based flame retardants, PBB and PBDE, have not been used, except for exempted applications.

• Please contact our Sales office when your application are considered the following:  
 The device's failure or malfunction may directly endanger human life (e.g. application for automobile/aircraft/medical/nuclear power devices, etc.)

• All specifications are subject to change without notice.

## ACH3218 TYPE SHAPES AND DIMENSIONS/CIRCUIT DIAGRAM

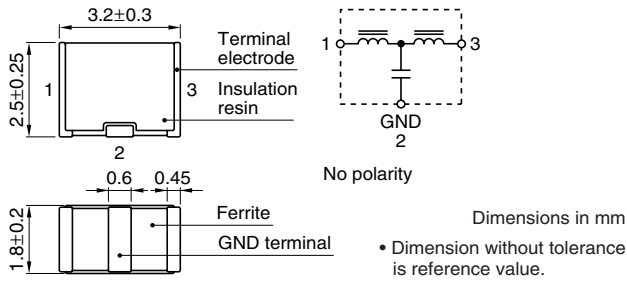

## RECOMMENDED PC BOARD PATTERN REFLOW SOLDERING

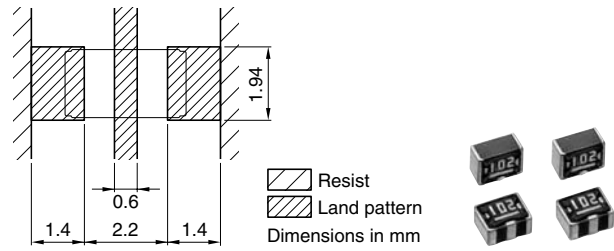

## ELECTRICAL CHARACTERISTICS

Part No.	25dB attenuation frequency range (MHz)	Rated voltage Edc (V)max.	Rated current (A)max.	DC resistance ( $\Omega$ )max. [Terminal No.1 to 3]	Insulation resistance (M $\Omega$ )min. [Terminal No.1 to 2/No.2 to 3]
ACH3218-223	11 to 55	20	1.5	0.06	1000
ACH3218-103	17 to 60	20	1.5	0.06	1000
ACH3218-682	22 to 75	20	1.5	0.06	1000
ACH3218-472	30 to 85	20	1.5	0.06	1000
ACH3218-332	37 to 90	20	1.5	0.06	1000
ACH3218-222	45 to 105	20	1.5	0.06	1000
ACH3218-152	60 to 115	20	1.5	0.06	1000
ACH3218-102	80 to 140	20	1.5	0.06	1000
ACH3218-681	95 to 150	20	1.5	0.06	1000
ACH3218-471	120 to 180	20	1.5	0.06	1000
ACH3218-331	130 to 210	20	1.5	0.06	1000
ACH3218-221	170 to 250	20	1.5	0.06	1000
ACH3218-151	205 to 280	20	1.5	0.06	1000
ACH3218-101	265 to 340	20	1.5	0.06	1000
ACH3218-680	340 to 420	20	1.5	0.06	1000
ACH3218-470	420 to 500	20	1.5	0.06	1000
ACH3218-330	500 to 600	20	1.5	0.06	1000
ACH3218-220	600 to 700	20	1.5	0.06	1000

## TYPICAL ELECTRICAL CHARACTERISTICS ATTENUATION vs. FREQUENCY CHARACTERISTICS

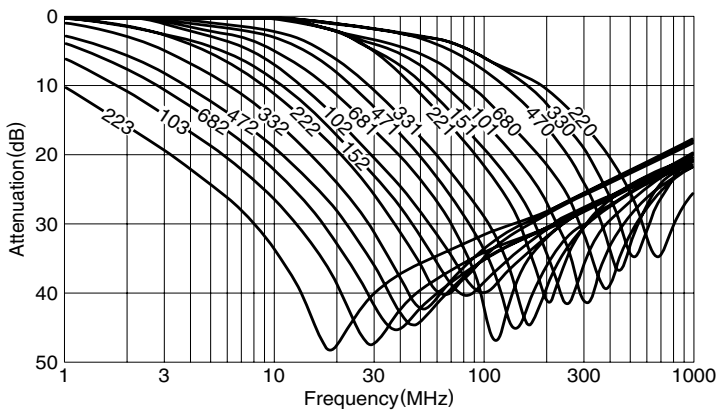

## MEASURING CIRCUIT

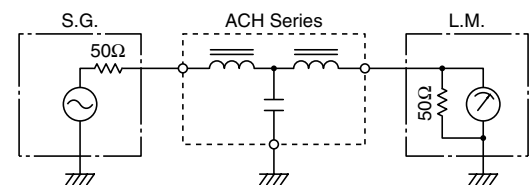

## ACH4518 TYPE

### SHAPES AND DIMENSIONS/CIRCUIT DIAGRAM

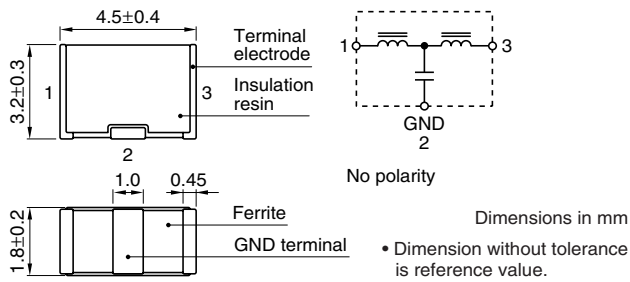

### RECOMMENDED PC BOARD PATTERN REFLOW SOLDERING

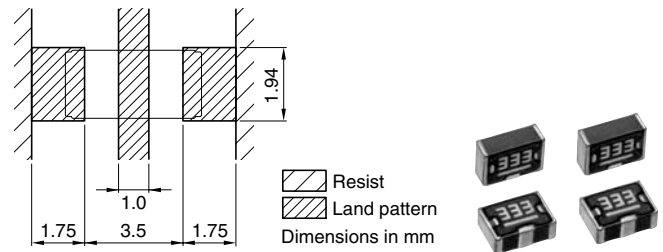

### ELECTRICAL CHARACTERISTICS

Part No.	25dB attenuation frequency range (MHz)	Rated voltage Edc (V)max.	Rated current (A)max.	DC resistance (Ω)max. [Terminal No.1 to 3]	Insulation resistance (MΩ)min. [Terminal No.1 to 2/No.2 to 3]
ACH4518-333	6 to 60	50	2.0	0.06	1000
ACH4518-223	9 to 65	50	2.0	0.06	1000
ACH4518-153	11 to 70	50	2.0	0.06	1000
ACH4518-103	15 to 75	50	2.0	0.06	1000
ACH4518-682	20 to 85	50	2.0	0.06	1000
ACH4518-472	25 to 90	50	2.0	0.06	1000
ACH4518-332	35 to 100	50	2.0	0.06	1000
ACH4518-222	40 to 110	50	2.0	0.06	1000
ACH4518-152	50 to 130	50	2.0	0.06	1000
ACH4518-102	65 to 150	50	2.0	0.06	1000
ACH4518-681	75 to 160	50	2.0	0.06	1000
ACH4518-471	95 to 180	50	2.0	0.06	1000
ACH4518-331	115 to 205	50	2.0	0.06	1000
ACH4518-221	150 to 250	50	2.0	0.06	1000
ACH4518-151	190 to 290	50	2.0	0.06	1000
ACH4518-101	235 to 335	50	2.0	0.06	1000
ACH4518-680	290 to 395	50	2.0	0.06	1000
ACH4518-470	360 to 460	50	2.0	0.06	1000
ACH4518-330	450 to 550	50	2.0	0.06	1000
ACH4518-220	530 to 650	50	2.0	0.06	1000

### TYPICAL ELECTRICAL CHARACTERISTICS

#### ATTENUATION vs. FREQUENCY CHARACTERISTICS

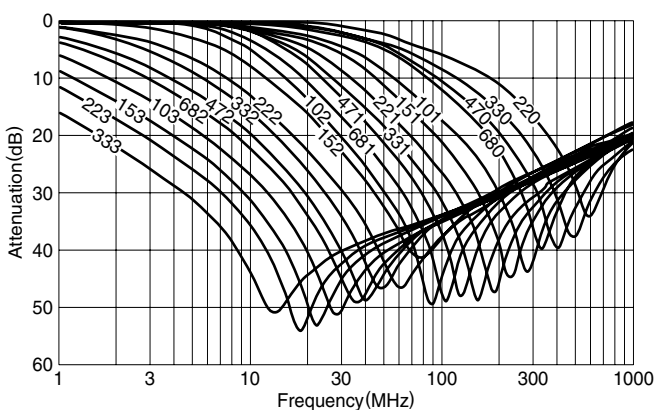

#### MEASURING CIRCUIT

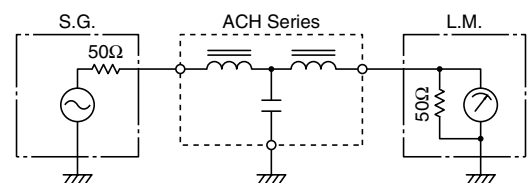

## PACKAGING STYLES

### REEL DIMENSIONS

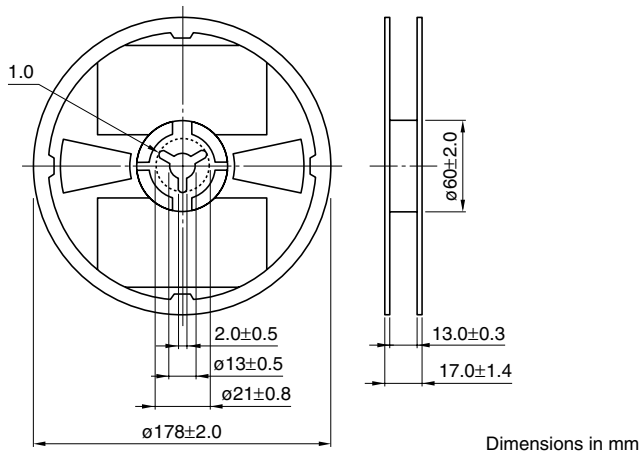

### TAPE DIMENSIONS

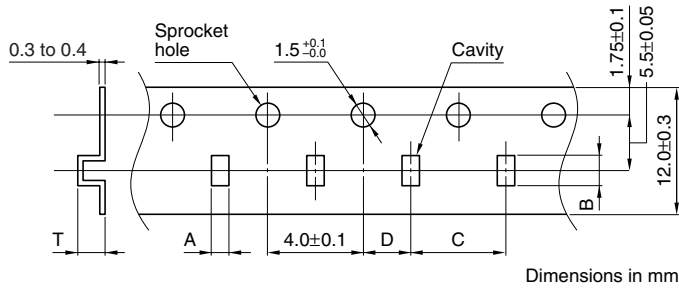

Type	A	B	C	D	T
321825	$2.2 \pm 0.2$	$3.7 \pm 0.2$	$4.0 \pm 0.1$	$2.0 \pm 0.05$	3.3max.
451832	$2.2 \pm 0.2$	$5.2 \pm 0.2$	$4.0 \pm 0.1$	$2.0 \pm 0.05$	3.8max.

