

# SPECIFICATION OF RADIAL TAPING & BULK SERIES

## APPLICATIONS

Oscillator coil , choke coil , and peaking coil

## ORDERING CODE

$\frac{K5B}{(1)} \frac{RH}{(2)} \frac{3.5 \times 4.7 \times 0.8}{(3)} - \frac{D}{(4)} - \frac{T}{(5)}$

- (1) MATERIAL CODE
- (2) PRODUCT CODE
- (3) SIZE CODE
- (4) SHAPE WOUND
- (5) TAPING

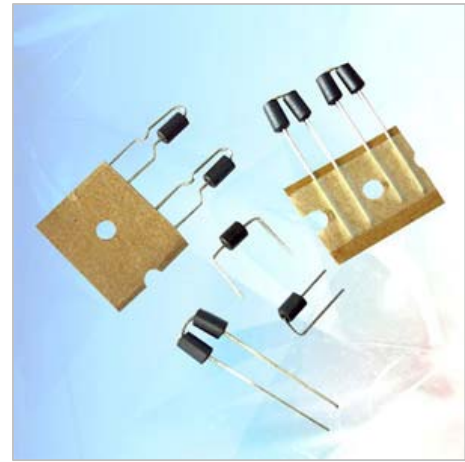

## SHAPE

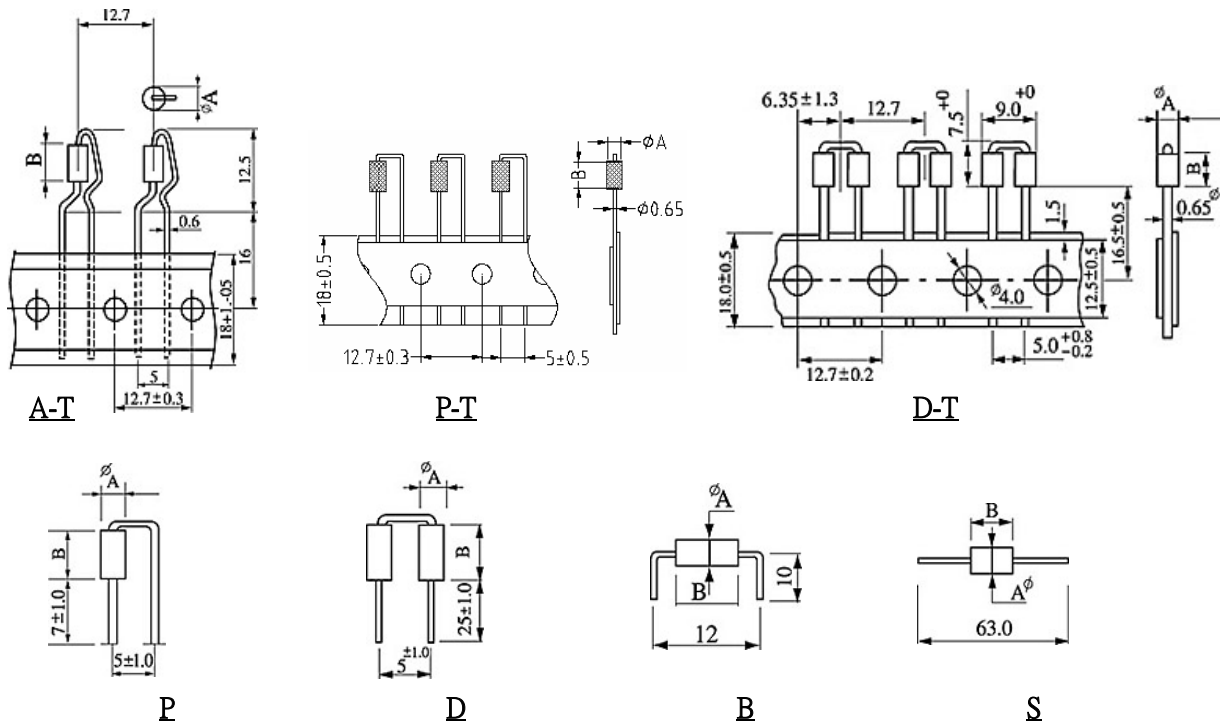

## DIMENSIONS & CHARACTERISTICS

UNIT:m/m

NO.	ORDERING CODE	A	B
1	RH 2.5*4*0.8-P-T	2.50±0.15	4.00±0.30
2	T 3.5*3*0.8-P-T	3.50±0.15	3.00±0.20
3	T 3.5*3*0.8-B	3.50±0.15	3.00±0.20
4	RH 3.5*4.5*0.8-A-T	3.50±0.15	4.50±0.30
5	RH 3.5*4.5*0.8-D-T	3.50±0.15	4.50±0.30
6	RH 3.5*4.5*0.8-B	3.50±0.15	4.50±0.30
7	RH 3.5*4.5*0.8-S	3.50±0.15	4.50±0.30
8	RH 3.5*4.7*0.8-A-T	3.50±0.15	4.70±0.30
9	RH 3.5*4.7*0.8-P-T	3.50±0.15	4.70±0.30
10	RH 3.5*4.7*0.8-D-T	3.50±0.15	4.70±0.30
11	RH 3.5*4.7*0.8-B	3.50±0.15	4.70±0.30
12	RH 3.5*4.7*0.8-S	3.50±0.15	4.70±0.30
13	RH 3.5*5*0.8-A-T	3.50±0.15	5.00±0.30
14	RH 3.5*5*0.8-D-T	3.50±0.15	5.00±0.30

※Other sizes are available upon request.

※All the date listed in this catalogue are for reference only, King Core reserves the right to alter or revise the specifications without prior notification.

# SPECIFICATION OF RADIAL TAPING & BULK SERIES

NO.	ORDERING CODE	A	B
15	RH 3.5*5*0.8-B	3.50±0.15	5.00±0.30
16	RH 3.5*5*0.8-S	3.50±0.15	5.00±0.30
17	RH 3.5*6*0.8-A-T	3.50±0.15	6.00±0.30
18	RH 3.5*6*0.8-P-T	3.50±0.15	6.00±0.30
19	RH 3.5*6*0.8-D-T	3.50±0.15	6.00±0.30
20	RH 3.5*6*0.8-B	3.50±0.15	6.00±0.30
21	RH 3.5*7.5*0.8-A-T	3.50±0.15	7.50±0.30
22	RH 3.5*7.5*0.8-D-T	3.50±0.15	7.50±0.30
23	RH 3.5*7.5*0.8-S	3.50±0.15	7.50±0.30
24	RH 3.5*8*0.8-P-T	3.50±0.15	8.00±0.30
25	RH 3.5*8*0.8-D-T	3.50±0.15	8.00±0.30
26	RH 3.5*8*0.8-B	3.50±0.15	8.00±0.30
27	RH 3.5*8.3*0.8-D-T	3.50±0.15	8.30±0.30
28	RH 3.5*9*0.8-A-T	3.50±0.15	9.00±0.30
29	RH 3.5*9*0.8-B	3.50±0.15	9.00±0.30
30	RH 3.5*9.5*0.8-P-T	3.50±0.15	9.50±0.40
31	RH 3.5*9.5*0.8-B	3.50±0.15	9.50±0.40
32	RH 3.5*11.4*0.8-S	3.50±0.15	11.40±0.40

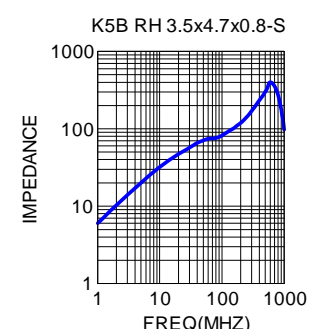
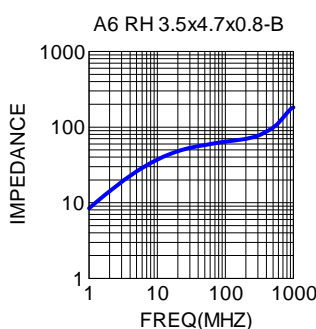
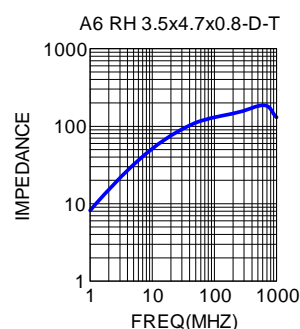
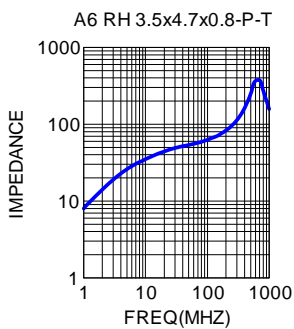
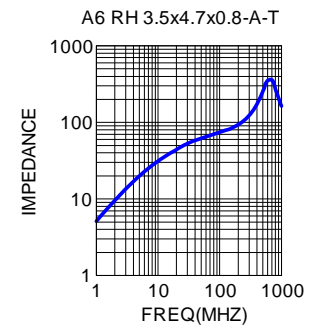
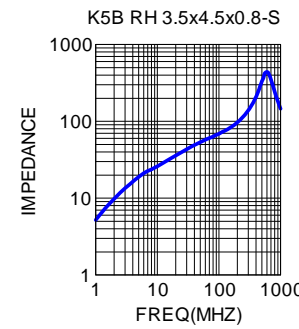
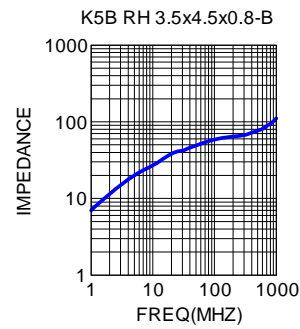
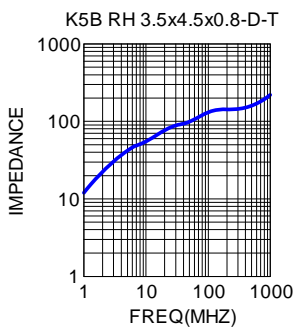
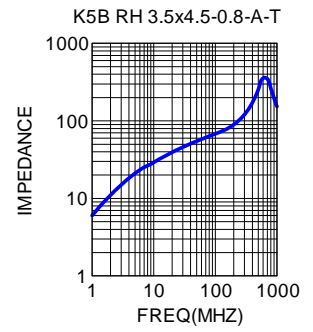
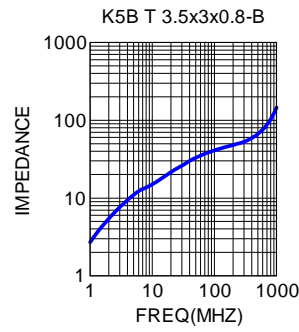
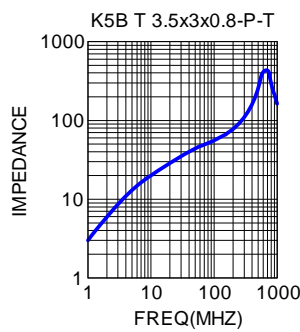
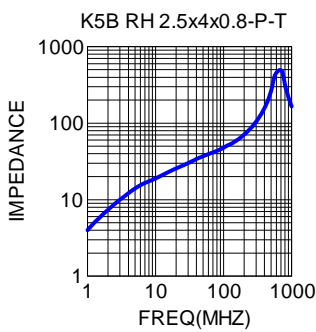

※Other sizes are available upon request.

※All the data listed in this catalogue are for reference only, King Core reserves the right to alter or revise the specifications without prior notification.

# SPECIFICATION OF RADIAL TAPING & BULK SERIES

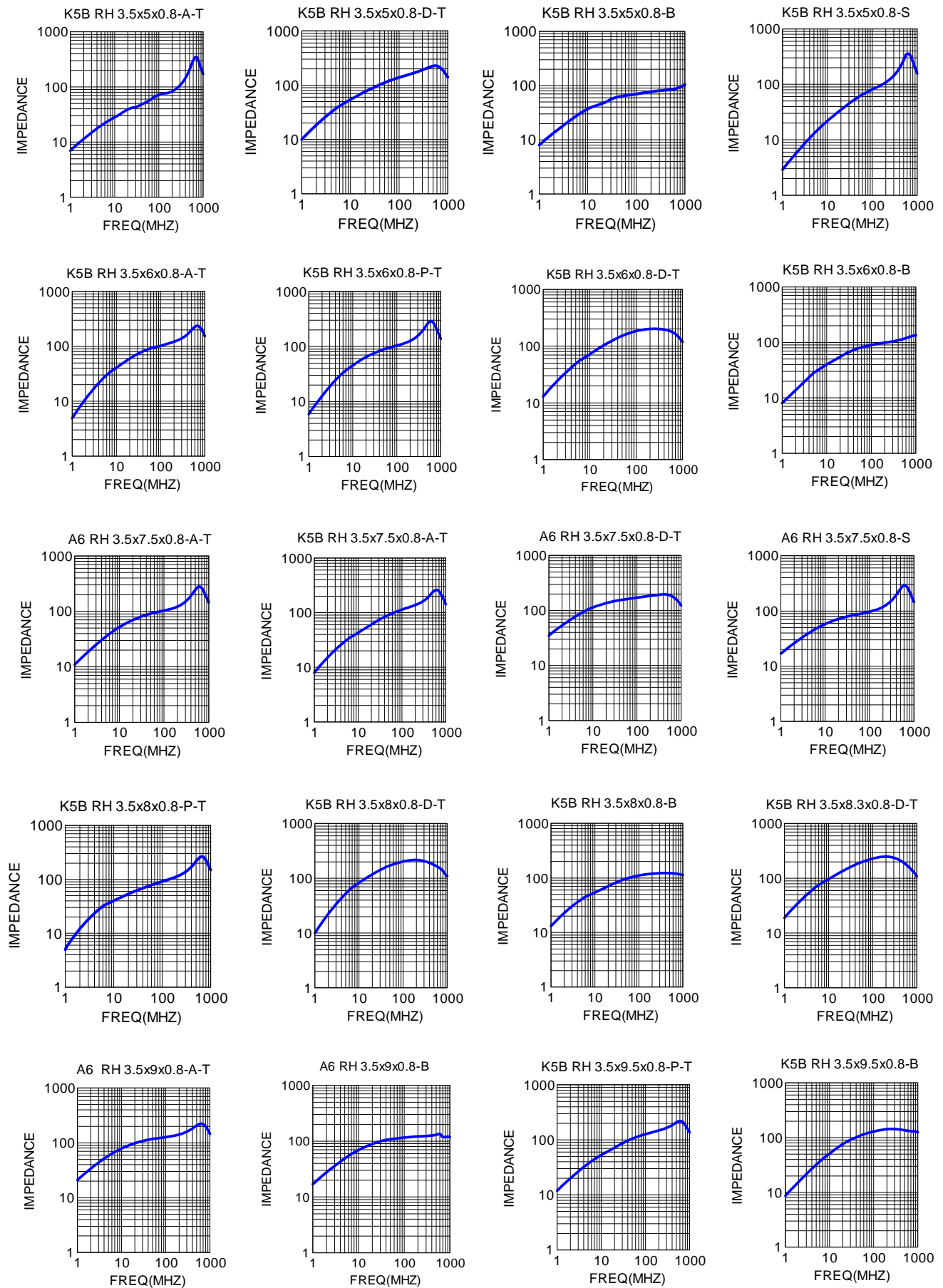

※Other sizes are available upon request.

※All the data listed in this catalogue are for reference only, King Core reserves the right to alter or revise the specifications without prior notification.

# SPECIFICATION OF RADIAL TAPING & BULK SERIES

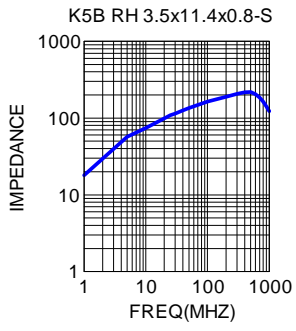

※Other sizes are available upon request.

※All the data listed in this catalogue are for reference only, King Core reserves the right to alter or revise the specifications without prior notification.